

SHOWPRO

NEPTUNE 400 WASH

USER MANUAL

LEDMOV647

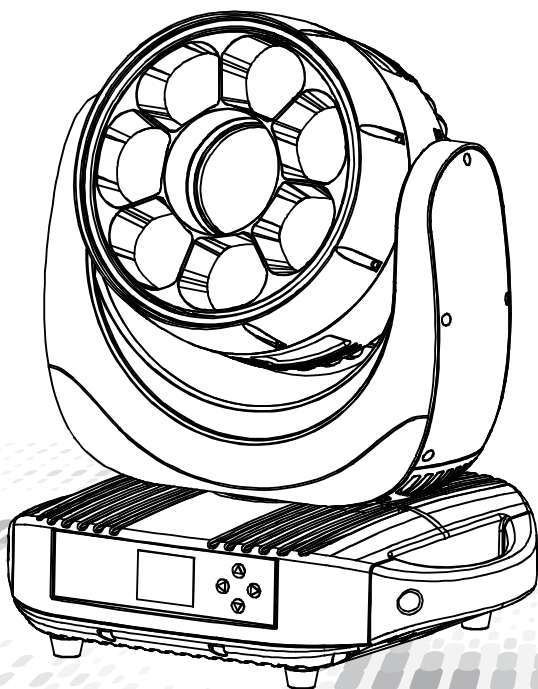

1 PRODUCT INTRODUCTION

1.1 Specification

Product Code	SS672XCEM
Dimenson	416×356×489(mm)
Weight	23KG
Rated Power	400W
Input Voltage	AC100~240VAC,50/60Hz
Frequency Range	4.8A
Ambient Temperature	-20℃~45℃
Beam Angle	6°~45°
Control Model	DMX512/RDM/ArtNet/sACN

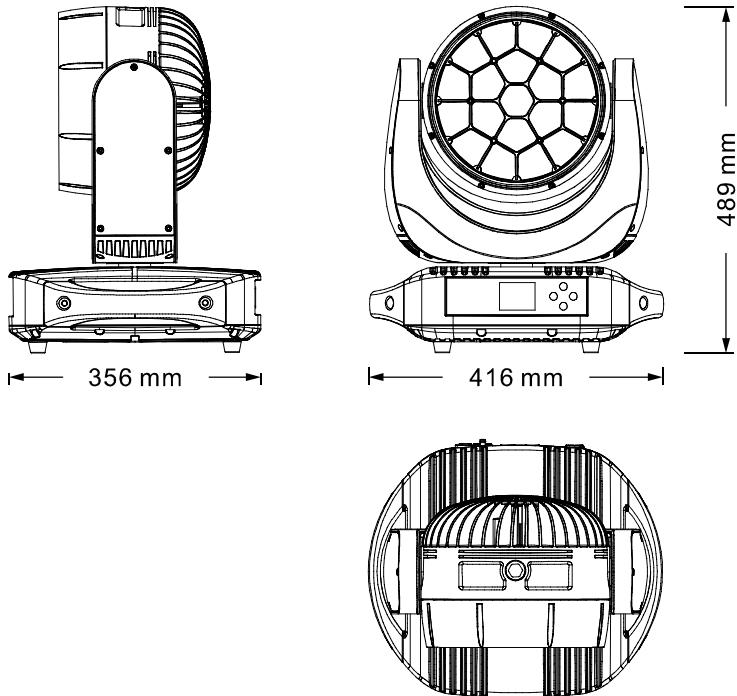

1.2 Safety warning

IMPORTANT

Always read the user manual before operation.

Please confirm that the power supply stated on the product is the same as the mains power supply in your area.

- This product must be installed by a qualified professional.
- Always operate the equipment as described in the user manual.
- A minimum distance of 0.5m must be maintained between the equipment and combustible surface.
- The product must always be placed in a well ventilated area.
- Always make sure that the equipment is installed securely.
- Do not stand close to the equipment and stare directly into the LED light source.
- Always disconnect the power supply before attempting and maintenance.
- Always make sure that the supporting structure is solid and can support the combined weight of the products.
- The earth wire must always be connected to the ground.
- Do not touch the power cables if your hands are wet.
- Please protect the fixture and avoid destroy during transport and installation. If there is any damage of the coating, that will influence the sea-salt and waterproof function.
- Do not open the fixture or remove any cover. Refer any service operation not described in this manual to an authorized Show Technology Service Centre.

ATTENTION



- This product left the place of manufacture in perfect condition. In order to maintain this condition and for safe operation, the user must always follow the instructions and safety warnings described in this user manual.
- Avoid shaking or strong impacts to any part of the equipment.
- Make sure that all parts of the equipment are kept clean and free of dust.
- Always make sure that the power connections are connected correct and secure.
- If there is any malfunction of the equipment, contact your distributor immediately.
- When transferring the product, it is advisable to use the original packaging in which the product left the factory.
- Shields, lenses or ultraviolet screens shall be changed if they have become damaged to such an extent that their effectiveness is impaired.
- The lamp (LED) shall be changed if it has become damaged or thermally deformed.



Caution, risk of electric shock
The light source contained in this luminaire shall only be replaced by the manufacturer or his service agent or a similar qualified person.

2 INSTALLATION

2.1 Mounting

The fixture can be mounted in any position. Always ensure that mounting surface can withstand 10 times the weight of the fixture.

Always use a safety cable when mounting the fixture in any elevated position.

Contact your ShowPRO supplier for assistance if you have any questions about how to install this product safely.

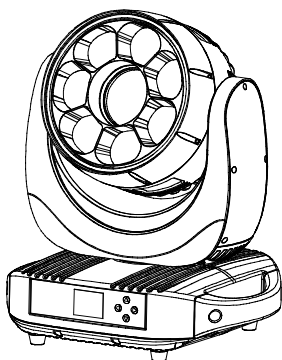

UPRIGHT

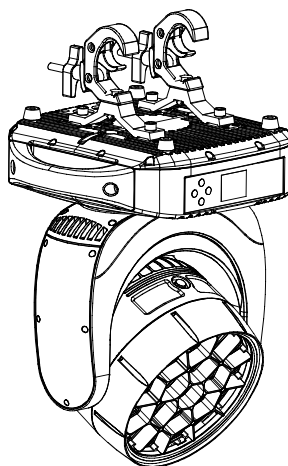

HANGING

2.2 Power Connections

This product uses input and output power cable is 1.5 square mm copper wire
Note:

If the signal cable is over 60m between the DMX512 controller and fixture or between two fixtures, then a DMX signal amplifier is needed as well.

3 DISPLAY PANEL OPERATION

3.1 Display Operation

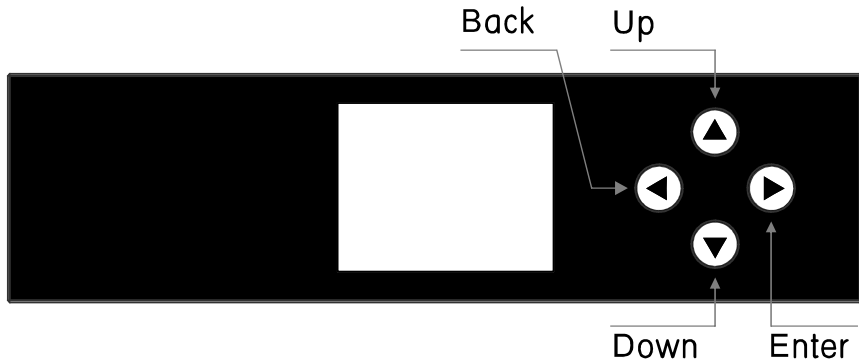

- Up: Scroll 'UP' through the menu list or increase the value of the current function.
- Down: Scroll 'DOWN' through the menu list or decrease the value of the current function.
- Left(Back): Scroll through the main menu.
- Right(Enter): Enter the currently selected menu or confirm the current function value.
- When the display locked, please unlock the display as below:
 1. Keep pressing BACK around 5sec, until the display shows inset password,
 2. Press “up down up down, enter” to unlock.

3.2 Menu

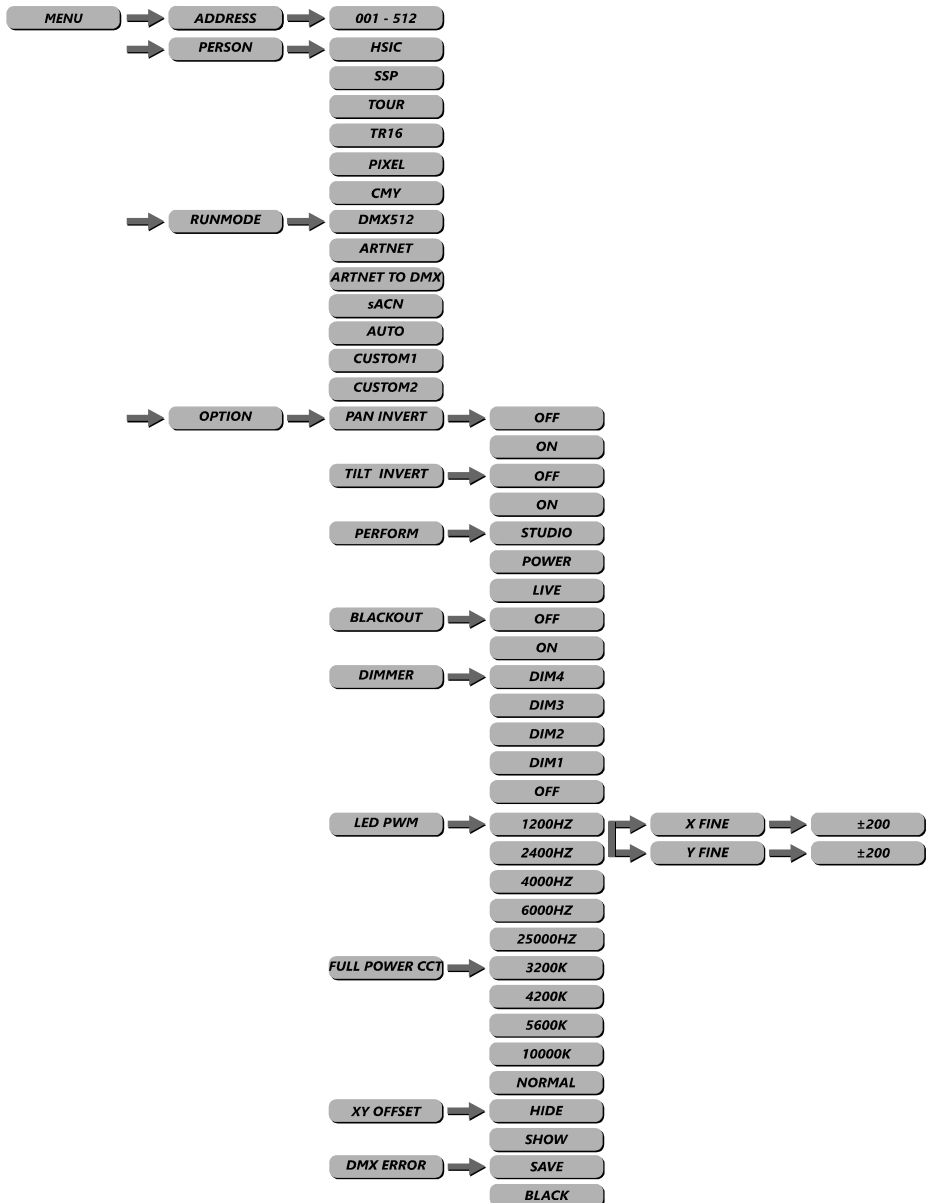

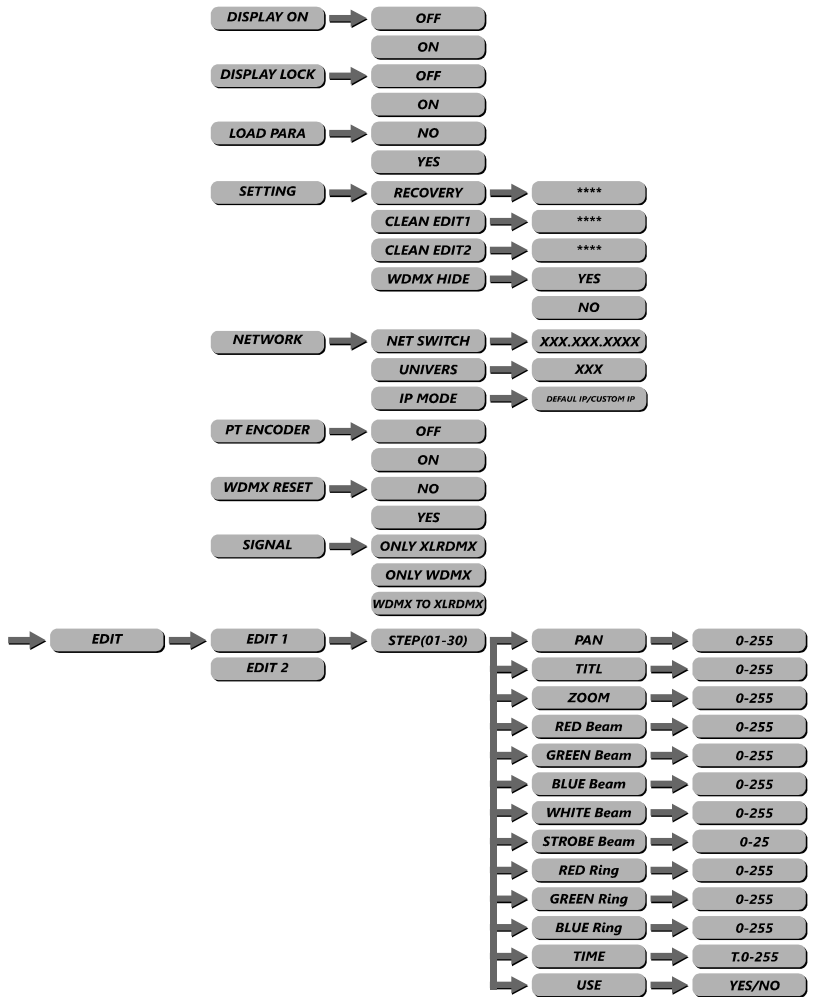

 NEPTUNE 400 WASH
SS672

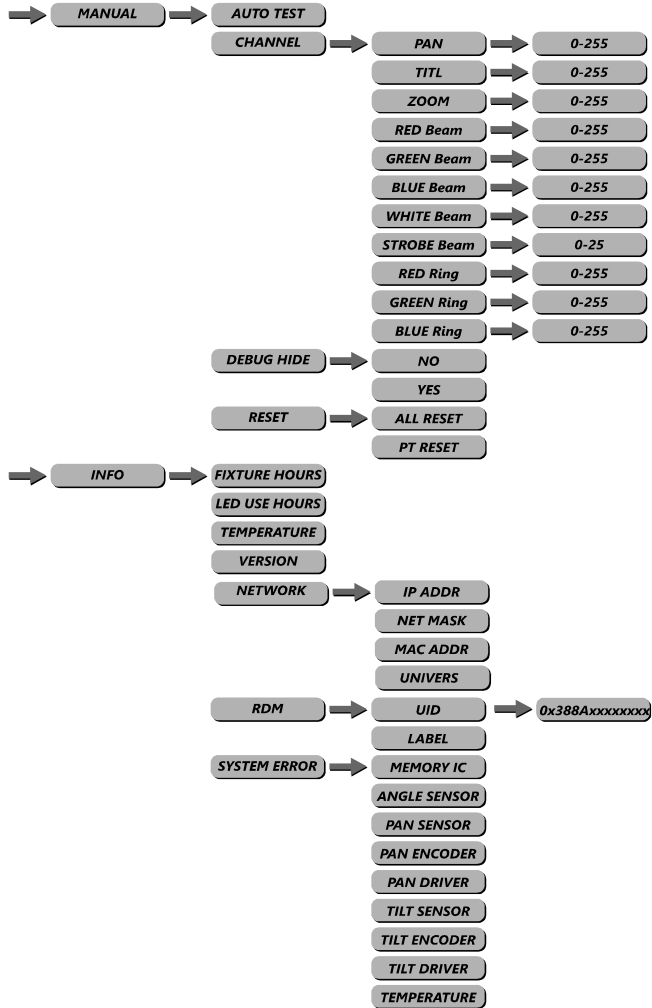

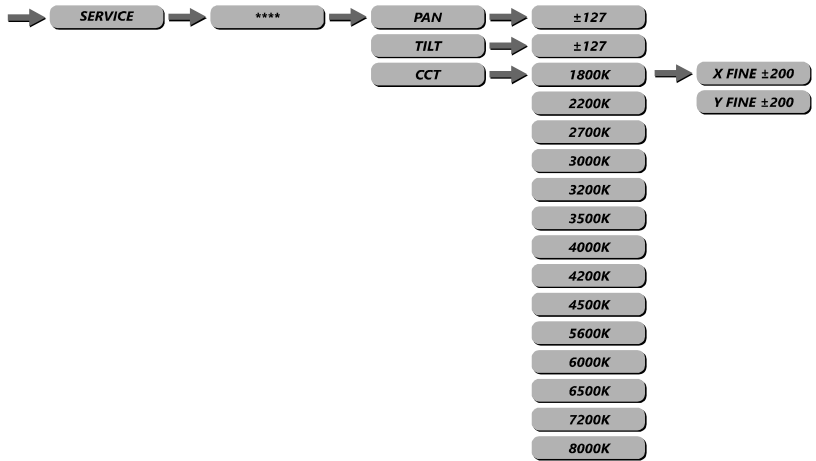

3.3 Dmx Address



- enter the DMX mode to set the dmx address.
- enter up/down select 1~512 address.
- enter menu return.

3.4 Personality

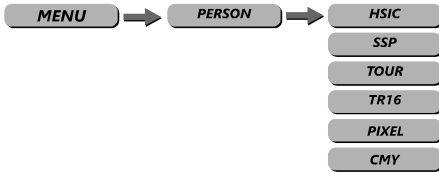

- enter the person mode to select DMX mode: HSIC,SSP,TOUR,TR16,PIXEL,CMY.

3.5 Runmode

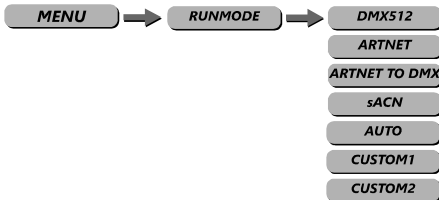

- **RUNMODE MENU** : select required run mode,there are some modes inside: DMX512 mode, artnet mode, artnet to DMX artnet to DMX mode, sACN mode, AUTO run mode, custom1 customer self-editing scene mode1, custom2 customer self-editing scene mode2 press down / up select mode.
- press enter accept,press menu return.

3.6 Performance

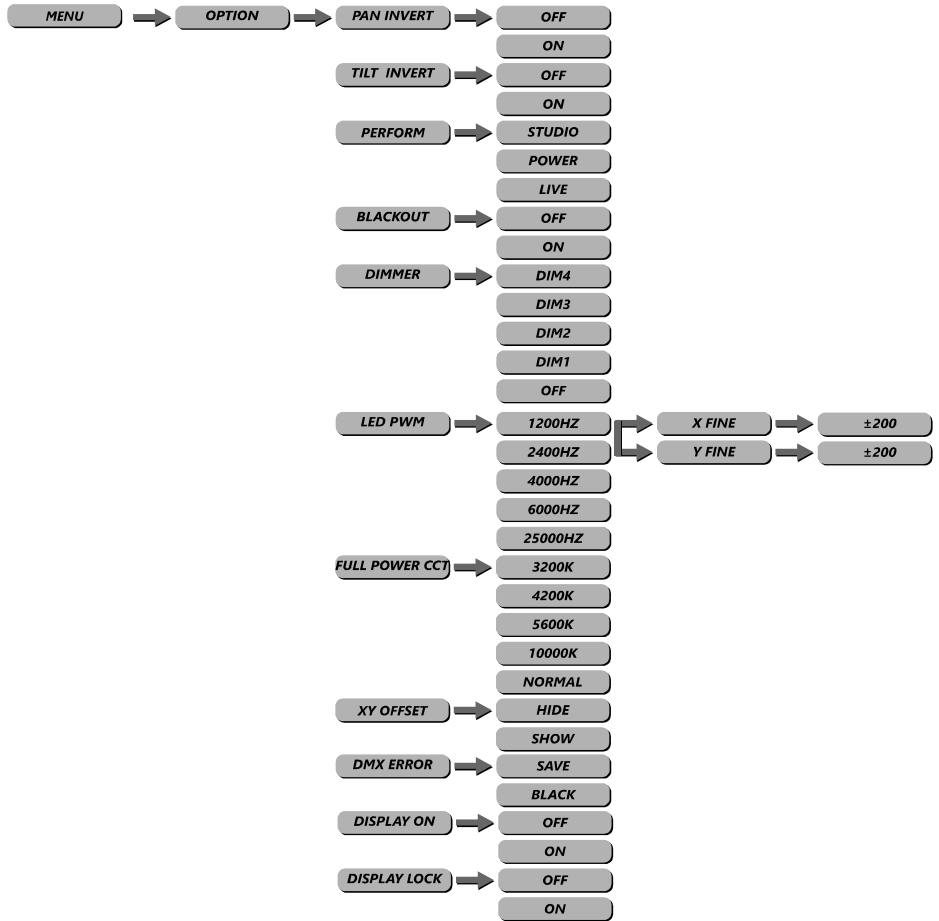

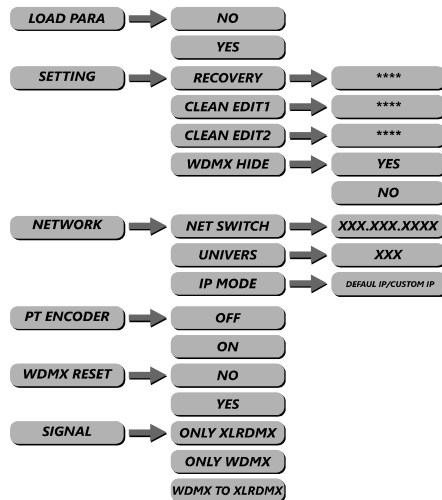

- Enter option into the machine set.
- **PAN/TILT:**
PAN INVERT menu:select NORM/INVERT for normal/inverted control of the PAN function.
TILT INVERT menu:select NORM/INVERT for normal/inverted control of the TILT function.
- **PERFORM:**
STUDIO: Noise control within 45dB, limiting power.
POWER: Noise control within 45dB, power reduction.
LIVE: Intelligent adjustment of wind speed, noise control within 55dB, power reduction, default to this mode.**PT SPEED menu:**select Slow/Fast as required PAN/TILT movement speed.
- **BLACKOUT** : select OFF for immediate activation of PAN/TILT blackout when selected using the control channel or ON for 3 second delay before activation.
- **DIMMER** menu: for selection of DIM1/DIM2/DIM3/DIM4/OFF special dimming curves.
- **LED PWM** : is PWM refresh rate bottom, press up/down to choose 1200hz~25000hz; Attention: the gray level of dimming will be reduced as the refresh rate increases.
- **FULL POWER CCT** : is the color temperature choose bottom, press UP/DOWN to choose, under full power,3200K,4200K,5600K,10000K can be chosen, when choose COLOR,3200K,4200K,5600K,10000K are not work, but choose NORMAL.
- **XY OFFSET** is the setting to hide the fine adjustment of the refresh frequency, select NO as not hidden, select YES as hidden, The default setting is YES.ct, **SHOW** as not hidden, select **HIDE** as hidden, The default setting is HIDE .

- **DMX ERROR menu:**select SAVE to maintain last command in case of DMX error or BLACK for blackout.
- **DISPLAY ON menu:**select LONG/SHORT/DISPLAY LOCK for length of time for display backlight.
- **DISPLAY LOCK :** choose off and on to close and open the screen lock mode in menu.
- **LOAD PARA :** to upload data, choose NO means do not upload data choose YES means upload data,
- **SETTING:**is a protect bottom,SETTINGS LOCK is the menu lock bottom, choose OFF means the menu lock bottom is off, choose ON means the menu lock bottom is on RECOVERY is the recover to default value.Press ENTER to password setting, press correct password UP+DOWN+UP+DOWN,and press ENTER ,if password is correct, display will show OK.
- **NETWORK :** network setting, press enter in, depending on the mode, you can hide unwanted features. for example net switch=off IP mode=default.UNIVERS :is data bulk setting, output series 0~255IP MODE : IP mode setting, default IP is default IP,CUSTOM IP : is customer's IP. Custom IP edit is customer's IP setting.
- **PT ENCODER :** XY encoder switch, off is close, on is open.
- **WDMX RESET :** reset wireless resetting, use for patch wireless signal, yes is clear the Receiver's message, press again patch wireless signal, no do not clear the receiver's message.
- **SIGNAL :** is signal setting, only XLR DMX is wire only, XLR DMX first is wire first, only WDMX is wireless only.WDMX firs is wireless first,WDMX to XLR DMX is wireless to wired.

3.7 EDIT

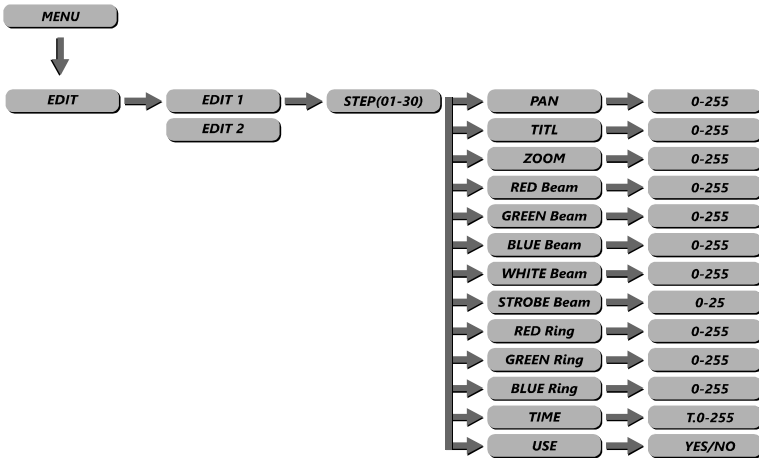

- Enter the Edit mode to edit the custom programs by adjusting the value of PAN、TILT、ZOOM、RED Beam、GREEN Beam、BLUE Beam、WHITE Beam、STROBE Beam、RED Ring、GREEN Ring、BLUE Ring、WHITE Ring、STROBE Ring、TIME、USE.
- Enter Use and select Yes to run the steps user need.
- Note:if user want to circulate the created steps,please set the last step's TIME as 0.
- For example,there are 3 steps,the setting should be like belowed:
Step 1 TIME =4 Use =Yes
Step 2 TIME =5 Use =Yes
Step 3 TIME =0 Use =Yes

3.8 Manual

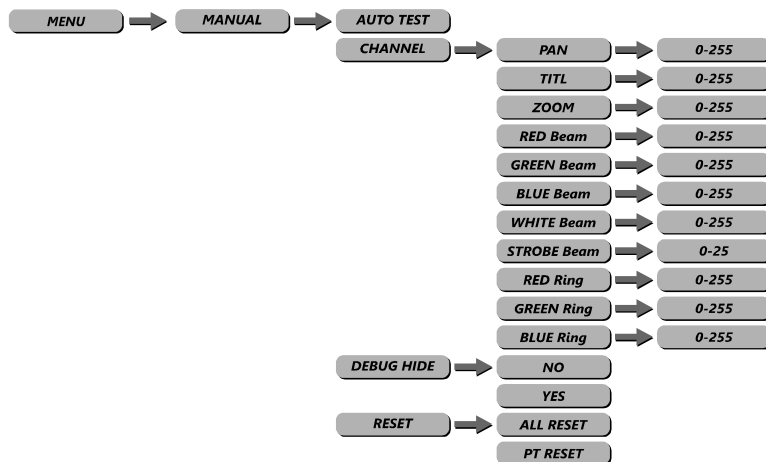

- Press enter into “AUTOTEST” at manual.
- **PAN** : pan set.
TILT : tilt set.
ZOOM : set the zoom of fixture.
RED BEAM / GREEN BEAM / BLUE BEAM / WHITE BEAM / STROBE BEAM: is the setting of the red / green / blue / white brightness, The larger the value, the brighter the brightness.
RED RING / GREEN RING / BLUE RING: is the red / green / blue brightness setting of the light. The larger the value, the brighter the brightness.
- **DEBUG HIDE** : is the factory testing mode. All stepper motors are not controlled by signal, it only works again after the reset. enter No out, Enter Yes in.
- **RESET** : set the reset:
ALL RESET : select Yes/No to carry out all reset.
PT RESET : select Yes/No to carry out PAN/TILT reset.

3.9 INFO

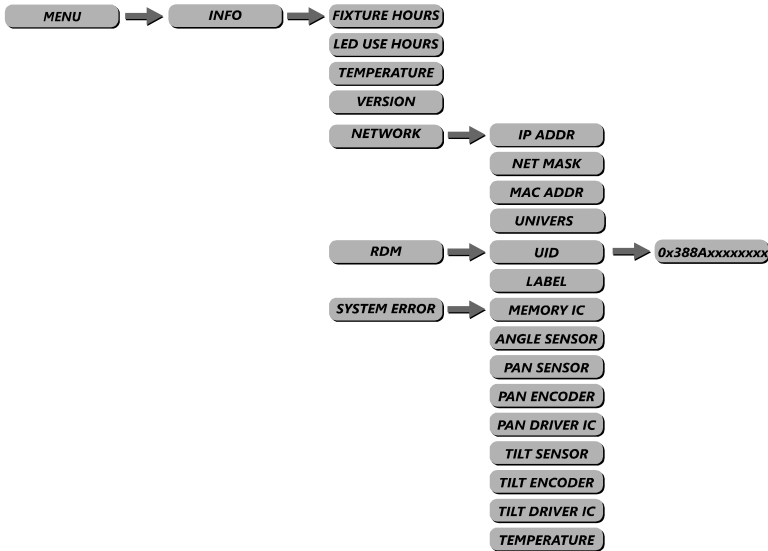

- Push “OK” button into the information search mode in menu info, push “up/down” to choose item.
- **FIXTURE HOURS** : is hours of fixture use.
- **LED USE HOURS** : is led use time.
- **TEMPERATURE** : LED working temperature.
- **VERSION** : is software versions.
- **NETWORK** : parachute network parameter
- **RDM** : check fixture's ID.
- **SYSTEM ERROR** : system information error Memory IC, AngleSensor, Pan Sensor, Pan Encoder, Pan DriveIC, TiltSensor, TiltEncoder, TiltDriveIC, Temperature.

3.10 Service

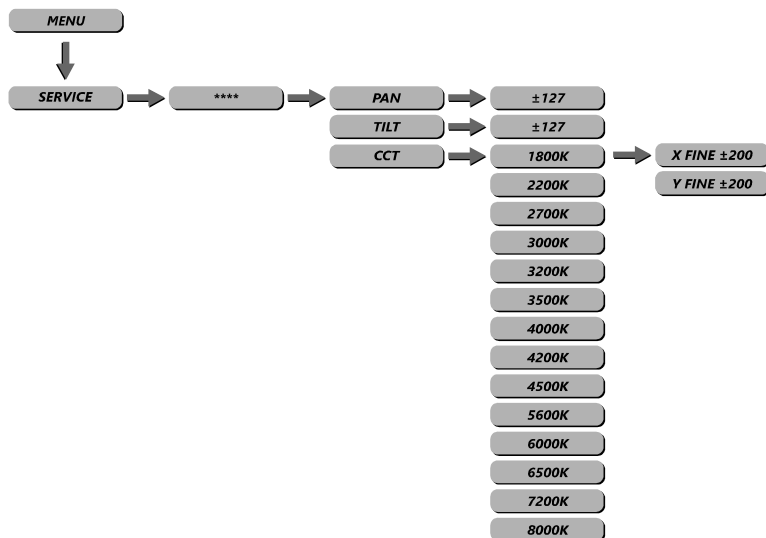

- Press ENTER into SERVICE Enter password to enter the options page.
- **PAN** : Pan position fine adjustment Push up and down buttons adjust ± 127 value.
- **TILT** : Tilt position fine adjustment Push up and down buttons adjust ± 127 value.
- **CCT** : Press ENTER to enter the **CCT** color temperature adjustment, then press DOWN/UP key to select the value of color temperature under the full power 1800K~8000K, you can press DOWN or UP to select DIMMER or X FINE or Y FINE, then select the value 0-255 if you need to adjust the color temperature.

4 USING A DMX512 CONTROLLER

4.1 Channel Assignment

Note: this product have DMX512 channel configuration: HSI,SSP,TOUR,TR16,PIXEL,CMY.

SSP (18CH)	TOUR (22CH)	TR16 (29CH)	VALUE	FUNCTION
CH.1	CH.1	CH.1	0-255	PAN
		CH.2	0-255	PAN FINE
CH.2	CH.2	CH.3	0-255	TITL
		CH.4	0-255	TITL FINE
CH.3	CH.3	CH.5	0-255	PT SPEED
CH.4	CH.4	CH.6	0-255	RED
		CH.7	0-255	RED FINE
CH.5	CH.5	CH.8	0-255	GREEN
		CH.9	0-255	GREEN FINE
CH.6	CH.6	CH.10	0-255	BLUE
		CH.11	0-255	BLUE FINE
CH.7	CH.7	CH.12	0-255	WHTIE
		CH.13	0-255	WHTIE FINE
CH.8	CH.8	CH.14	0-255	DIMMER
		CH.15	0-255	DIMMER FINE
			STROBE	
CH.9	CH.9	CH.16	0-9	NO FUNCTION
			10-99	STROBE FROM (SLOW TO FAST , 0-25Hz)
			100-109	NO FUNCTION
			110-179	LIGHTNING STROBE
			180-189	NO FUNCTION
			190-255	RANDOM STROBE
			COLOR MARCOS	
			0-10	NO FUNCTION
			11-30	RED 100% / GREEN UP / BLUE 0%
			31-50	RED DOWN / GREEN 100% / BLUE 0%
			51-70	RED 0% / GREEN 100% / BLUE UP
			71-90	RED 0% / GREEN DOWN / BLUE 100%
			91-110	RED UP / GREEN 0% / BLUE 100%

SSP (18CH)	TOUR (22CH)	TR16 (29CH)	VALUE	FUNCTION
CH.10	CH.10	CH.17	111-130	RED 100% /GREEN 0%/BLUE DOWN
			131-150	RED 100%/GREEN UP/BLUE UP
			151-170	RED DOWN/GREEN DOWN/BLUE 100%
			171-195	ALL LED AT FULL OUTPUT
			196-199	1800K
			200-203	2200K
			204-207	2700K
			208-211	3000K
			212-215	3200K
			216-219	3500K
			220-223	4000K
			224-227	4200K
			228-231	4500K
			232-235	5600K
			236-239	6000K
			240-243	6500K
			244-247	7200K
248-255	8000K			
CH.11	CH.11	CH.18	STATIC PIXEL	
			0-9	NO FUNCTION
			10-13	1
			14-17	2
			18-21	3
			22-25	4
			26-29	5
			30-33	6
			34-37	7
			38-41	8
			42-45	9
			46-49	10
			50-53	11
			54-57	12
			58-61	13
62-65	14			
66-69	15			



NEPTUNE 400 WASH SS672

SSP (18CH)	TOUR (22CH)	TR16 (29CH)	VALUE	FUNCTION
			70-73	16
			74-77	17
			78-81	18
			82-85	19
			86-89	1,2
			90-93	3,4
			94-97	5,6
			98-101	7,8
			102-105	9,10
			106-109	11,12
			110-113	13,14
			114-117	15,16
			118-121	17,18
			122-125	19,1
			126-129	1,2,3
			130-133	1,4,5
			134-137	1,6,7
			138-141	2,8,9
			142-145	3,10,11
			146-149	4,12,13
			150-153	5,14,15
			154-157	6,16,17
			158-161	7,18,19
			162-165	1,2,3,4
			166-169	1,5,6,7
			170-173	8,9,10,11
			174-177	12,13,14,15
			178-181	16,17,18,19
			182-185	2,3,4,5,6,7
			186-189	1,4,5,6,7
			190-193	8,9,10,11,12
			194-197	13,14,15,16,17
			198-201	18,19,8,9,10
			202-205	1,2,3,4,6,7
			206-209	8,9,10,11,12,13

SSP (18CH)	TOUR (22CH)	TR16 (29CH)	VALUE	FUNCTION
			210-213	14,15,16,17,18,19
			214-217	1,2,3,4,5,6,7
			218-221	8,9,10,11,12,13,14,15,16,17,18,19
			222-225	1,2,3,4,8,9,10,11,12,13
			226-229	1,5,6,7,14,15,16,17,18,19
			230-233	1,2,3,6,7,8,9,10,17,18,19
			234-237	1,3,4,5,6,11,12,13,14,15,16
			238-241	1,2,3,4,5,6,7,8,10,12,14,16,18
			242-245	1,2,3,4,5,6,7,9,11,13,15,17,19
			246-249	1,2,4,6,8,10,12,14,16,18
			250-253	1,3,5,7,9,11,13,15,17,19
			254-255	null
			PIXEL EFFECT	
			0-9	NO FUNCTION
			10-13	1-19(Single light cycling operation,associated with CH4-CH10)
			14-17	19-1(Single light cycling operation,associated withCH4-CH10)
			18-21	1-19-1(Single light cycling operation,associated with CH4-CH10)
			22-25	1-10 and 19-10(1&19light up in the same time ,gethering from 2 sides to the center in turn .when it is at 10 ,spreading from the center to the 2 sides,associated with CH4-CH10)
			26-29	1 (Illuminance 30%) - 2 (Illuminance60%) 3 (Illuminance100%) , (associated with CH4-CH10)
				2 (Illuminance 30%) - 3 (Illuminance60%) 4 (Illuminance100%) , (associated with CH4-CH10)
				3 (Illuminance 30%) - 4 (Illuminance60%) 5 (Illuminance100%) , (associated with CH4-CH10)
				4 (Illuminance 30%) - 5 (Illuminance60%) 6 (Illuminance100%) , (associated with CH4-CH10)
				5 (Illuminance 30%) - 6 (Illuminance60%) 7 (Illuminance100%) , (associated with CH4-CH10)
				18 (Illuminance 30%) - 19 (Illuminance60%) 1 (Illuminance100%) , (associated with CH4-CH10)
				19 (Illuminance 30%) - 1 (Illuminance60%) 2 (Illuminance100%) , (associated with CH4-CH10)
			30-33	7 (Illuminance 30%) - 6 (Illuminance60%) 5 (Illuminance100%) , (associated with CH4-CH10)
				6 (Illuminance 30%) - 5 (Illuminance60%) 4 (Illuminance100%) , (associated with CH4-CH10)
				5 (Illuminance 30%) - 4 (Illuminance60%) 3 (Illuminance100%) , (associated with CH4-CH10)
				4 (Illuminance 30%) - 3 (Illuminance60%) 2 (Illuminance100%) , (associated with CH4-CH10)
				3 (Illuminance 30%) - 2 (Illuminance60%) 1 (Illuminance100%) , (associated with CH4-CH10)
				2 (Illuminance 30%) - 1 (Illuminance60%) 19 (Illuminance100%) , (associated with CH4-CH10)
				1 (Illuminance 30%) - 19 (Illuminance60%) 18 (Illuminance100%) , (associated with CH4-CH10)
			34-37	1-19(Single 2700k cycling operation ,the background effect associated with CH4-CH10)
			38-41	19-1(Single 2700k cycling operation ,the background effect associated with CH4-CH10)
			42-45	1-19-1(Single 2700k cycling operation ,the background effect associated with CH4-CH10)



NEPTUNE 400 WASH

SS672

SSP (18CH)	TOUR (22CH)	TR16 (29CH)	VALUE	FUNCTION
			46-49	1-10 and 19-10(1<2700k>&7<2700K>light up in the same time,getting from 2 sides to the center in turn .when it is at 10,spreading from the center to the 2 sides,the background effect associated with CH4-CH10)
			50-53	1-19(Single 6000k cycling operation ,the background effect associated with CH4-CH10)
			54-57	19-1(Single 6000k cycling operation ,the background effect associated with CH4-CH10)
			58-61	1-19-1(Single 6000k cycling operation ,the background effect associated with CH4-CH10)
			62-65	1-10 and 19-10(1<6000k>&7<6000K>light up in the same time,getting from 2 sides to the center in turn .when it is at 10,spreading from the center to the 2 sides,the background effect associated with CH4-CH10)
			66-69	Red background ,illuminate adjustable . 100% green lightness runs(1-19)
			70-73	Red background ,illuminate adjustable . 100% green lightness runs(19-1)
			74-77	Red background ,illuminate adjustable . 100% green lightness runs(1-19-1)
			78-81	Red background ,illuminate adjustable . 100% green lightness runs(1-10,19-10,1&19light up in the same time,getting from 2 sides to the center in turn .when it is at 10,spreading from the center to the 2 sides.associated with CH4-CH10.
			82-85	Green background ,illuminate adjustable . 100% blue lightness runs(1-19)
			86-89	Green background ,illuminate adjustable . 100% blue lightness runs(19-1)
			90-93	Green background ,illuminate adjustable . 100% blue lightness runs(1-19-1)
	CH.12	CH.19	94-97	Green background ,illuminate adjustable . 100% blue lightness runs(1-10,19-10,1&19light up in the same time,getting from 2 sides to the center in turn .when it is at 10,spreading from the center to the 2 sides.associated with CH4-CH10.
			98-101	Blue background ,illuminate adjustable . 100% green lightness runs(1-19)
			102-105	Blue background ,illuminate adjustable . 100% green lightness runs(19-1)
			106-109	Blue background ,illuminate adjustable . 100% green lightness runs(1-19-1)
			110-113	Blue background ,illuminate adjustable . 100% green lightness runs(1-10,19-10,1&19 light up in the same time,getting from 2 sides to the center in turn .when it is at 10,spreading from the center to the 2 sides.associated with CH4-CH10.
			114-117	Red background ,illuminate adjustable . 100% white lightness runs(1-19)
			118-121	Red background ,illuminate adjustable . 100% white lightness runs(19-1)
			122-125	Red background ,illuminate adjustable . 100% white lightness runs(1-19-1)
			126-129	Red background ,illuminate adjustable . 100% white lightness runs(1-10,19-10,1&19 light up in the same time,getting from 2 sides to the center in turn .when it is at 10,spreading from the center to the 2 sides.associated withCH4-CH10.
			130-133	White background ,illuminate adjustable . 100% red lightness runs(1-19)
			134-137	White background ,illuminate adjustable . 100% red lightness runs(19-1)
			138-141	White background ,illuminate adjustable . 100% red lightness runs(1-19-1)
			142-145	White background ,illuminate adjustable . 100% red lightness runs(1-10,19-10,1&19 light up in the same time,getting from 2 sides to the center in turn .when it is at 10,spreading from the center to the 2 sides.associated with CH4-CH10.
			146-149	Green background ,illuminate adjustable . 100% white lightness runs(1-19)
			150-153	Green background ,illuminate adjustable . 100% white lightness runs(19-1)
			154-157	Green background ,illuminate adjustable . 100% white lightness runs(1-19-1)

SSP (18CH)	TOUR (22CH)	TR16 (29CH)	VALUE	FUNCTION
			158-161	Green background ,illuminate adjustable . 100% white lightness runs(1-10,19-10),1&19 light up in the same time ,getthering from 2 sides to the center in turn .when it is at 10,sperading from the center to the 2 sides.associated with CH4-CH10.
			162-165	Blue background ,illuminate adjustable . 100% white lightness runs(1-19)
			166-169	Blue background ,illuminate adjustable . 100% white lightness runs(19-1)
			170-173	Blue background ,illuminate adjustable . 100% white lightness runs(1-19-1)
			174-177	Blue background ,illuminate adjustable . 100% white lightness runs(1-10,19-10),1&19 light up in the same time ,getthering from 2 sides to the center in turn .when it is at 10,sperading from the center to the 2 sides.associated with CH4-CH10.
			178-181	Green background ,illuminate adjustable . 100% red lightness runs(1-19)
			182-185	Green background ,illuminate adjustable . 100% red lightness runs(19-1)
			186-189	Green background ,illuminate adjustable . 100% red lightness runs(1-19-1)
			190-193	Green background ,illuminate adjustable . 100% red lightness runs(1-10,19-10),1&19 light up in the same time ,getthering from 2 sides to the center in turn .when it is at 10,sperading from the center to the 2 sides.associated with CH4-CH10.
			194-197	Blue background ,illuminate adjustable . 100% red lightness runs(1-19)
			198-201	Blue background ,illuminate adjustable . 100% red lightness runs(19-1)
			202-205	Blue background ,illuminate adjustable . 100% red lightness runs(1-19-1)
			206-209	Blue background ,illuminate adjustable . 100% red lightness runs(1-10,19-10),1&19 light up in the same time ,getthering from 2 sides to the center in turn .when it is at 10,sperading from the center to the 2 sides.associated with CH4-CH10.
			210-215	small-middle-big-middle-small circular ring
			216-221	(1,4,5)-(2,5,6)-(3,6,7)-(4,7,1)-(5,1,2)-(6,2,3)-(7,3,4)
			222-227	(1,2,5,6)-(2,3,6,7)-(3,4,7,1)-(4,5,1,2)-(5,6,2,3)-(6,7,3,4)-(7,1,4,5)
			228-230	1,2 circular ring
			231-233	1,2,3 circular ring
			234-236	1,2,3,4 circular ring
			237-239	1-3blue , 4-7red
			240-242	1-3cyan , 4-7orange
			243-245	1-3purple , 4-7yellow
			246-248	1-3orange , 4-7green
			249-251	1-3red , 4-7purple
			252-254	1-3yellow , 4-7blue
			255	1-3green , 4-7purple
	CH.13	CH.20	0-255	AUTO SPEED ADJUSTMENT(SLOW TO FAST)
CH.10	CH.14	CH.21	0-255	ZOOM
CH.11	CH.15	CH.22	0-255	RED RING
CH.12	CH.16	CH.23	0-255	GREEN RING
CH.13	CH.17	CH.24	0-255	BULE RING



NEPTUNE 400 WASH SS672

SSP (18CH)	TOUR (22CH)	TR16 (29CH)	VALUE	FUNCTION
CH.14	CH.18	CH.25	Ring Color Presets	
			000-009	Open
			010-014	RED
			015-019	GREEN
			020-024	BLUE
			025-029	Yellow
			030-034	Magenta
			035-039	Cyan
			040-044	WHITE
			045-049	Violet blue
			050-054	Light blue
			055-059	Wine red
			060-064	May green
			065-069	Reseda green
			070-074	Blue lilac
			075-079	Moss green
			080-084	Signal violet
			085-089	Red lilac
			090-094	Purple red
			095-099	Green brown
			100-104	Pale green
			105-109	Ruby red
			110-114	Flame red
			115-119	Red orange
			120-124	Rose
			125-129	Honey yellow
			130-134	Light Pin
			135-139	Deep orange
			140-144	Lemmon
			145-149	Golden yellow
150-154	Pastel orange			
155-159	Cream			
160-164	Melon yellow			
165-169	Luminous orange			
170-174	Luminouse yellow			

SSP (18CH)	TOUR (22CH)	TR16 (29CH)	VALUE	FUNCTION
			175-179	Open
			180-248	Stop
			249-255	Open
CH.15	CH.19	CH.26	Color FX	
			000-009	Open
			010-023	FX1
			024-037	FX2
			038-051	FX3
			052-065	FX4
			066-079	FX5
			080-93	FX6
			094-107	FX7
			108-121	FX8
			122-135	FX9
			136-149	FX10
			150-163	FX11
			164-177	FX12
			178-191	Fx13
			192-205	Fx14
			206-219	Fx15
			220-233	Fx16
			234-247	Fx17
			248-255	Close
CH.16	CH.20	CH.27	0-255	Ring Speed(SPEED 1 → 100%)
CH.17	CH.21	CH.28	0-255	Ring Dimmer
CH.18	CH.22	CH.29	Control (will be active after 5 seconds on the corresponding value)	
			0-9	NO FUNCTION
			10-19	PAN/TILT BLACK ACTIVATED
			20-29	PAN/TILT BLACK DEACTIVATED
			30-59	DIM0
			60-69	DIM1
			70-79	DIM2
			80-89	DIM3
			90-99	DIM4
			100-139	PWM 1200Hz



NEPTUNE 400 WASH SS672

			140-149	PWM 2000Hz
			150-159	PWM 2400Hz
			160-169	PWM 6000Hz
			170-179	PWM 25000Hz
			180-189	STUDIO
			190-199	POWER
			200-209	LIVE
			210-219	pan/tilt reset
			220-229	ZOOM RESET
			230-239	Total Reset
			240-255	NO FUNCTION

HSIC (Ch20)	VALUE	FUNCTION
CH.1	0-255	PAN
CH.2	0-255	PAN FINE
CH.3	0-255	TITL
CH.4	0-255	TITL FINE
CH.5	0-255	PT SPEED
CH.6	0-255	INTENSIYT
CH.7	0-255	HUE
CH.8	0-255	HUE FINE
CH.9	0-255	SATURATION
		CCT
CH.10	0-10	NO FUNCTION
	11-28	1800K
	29-46	2200K
	47-64	2700K
	65-82	3000K
	83-100	3200K
	101-118	3500K
	119-136	4000K
	137-154	4200K
	155-172	4500K
	173-190	5600K
	191-208	6000K
	209-226	6500K

HSIC (Ch20)	VALUE	FUNCTION
	227-244	7200K
	245-255	8000K
	STROBE	
	0-9	NO FUNCTION
	10-99	STROBE FROM (SLOD TO FAST , 0-25Hz)
CH.11	100-109	NO FUNCTION
	110-179	LIGHTNING STROBE
	180-189	NO FUNCTION
	190-255	RANDOM STROBE
CH.12	0-255	ZOOM
CH.13	0-255	RED RING
CH.14	0-255	GREEN RING
CH.15	0-255	BULE RING
	Ring Color Presets	
	000-009	Open
	010-014	RED
	015-019	GREEN
	020-024	BLUE
	025-029	Yellow
	030-034	Magenta
	035-039	Cyan
	040-044	WHITE
	045-049	Violet blue
	050-054	Light blue
CH.16	055-059	Wine red
	060-064	May green
	065-069	Reseda green
	070-074	Blue lilac
	075-079	Moss green
	080-084	Signal violet
	085-089	Red lilac
	090-094	Purple red
	095-099	Green brown
	100-104	Pale green
	105-109	Ruby red



NEPTUNE 400 WASH SS672

HSIC (Ch20)	VALUE	FUNCTION
	110-114	Flame red
	115-119	Red orange
	120-124	Rose
	125-129	Honey yellow
	130-134	Light Pin
	135-139	Deep orange
	140-144	Lemmon
	145-149	Golden yellow
	150-154	Pastel orange
	155-159	Cream
	160-164	Melon yellow
	165-169	Luminous orange
	170-174	Luminouse yellow
	175-179	Open
	180-248	Stop
	249-255	Open
	CH.17	Color FX
000-009		Open
010-023		FX1
024-037		FX2
038-051		FX3
052-065		FX4
066-079		FX5
080-093		FX6
094-107		FX7
108-121		FX8
122-135		FX9
136-149		FX10
150-163		FX11
164-177		FX12
178-191		Fx13
192-205		Fx14
206-219		Fx15
220-233		Fx16
234-247	Fx17	

HSIC (Ch20)	VALUE	FUNCTION
	248-255	Close
CH.18	0-255	Ring Speed(SPEED 1 → 100%)
CH.19	0-255	Ring Dimmer
CH.20	Control (will be active after 5 seconds on the corresponding value)	
	0-9	NO FUNCTION
	10-19	PAN/TILT BLACK ACTIVATED
	20-29	PAN/TILT BLACK DEACTIVATED
	30-59	DIM0
	60-69	DIM1
	70-79	DIM2
	80-89	DIM3
	90-99	DIM4
	100-139	PWM 1200Hz
	140-149	PWM 2000Hz
	150-159	PWM 2400Hz
	160-169	PWM 6000Hz
	170-179	PWM 25000Hz
	180-189	STUDIO
	190-199	POWER
	200-209	LIVE
	210-219	pan/tilt reset
	220-229	ZOOM RESET
	230-239	Total Reset
240-255	NO FUNCTION	



NEPTUNE 400 WASH SS672

PIXEL (Ch92)	VALUE	FUNCTION
CH.1	0-255	PAN
CH.2	0-255	PAN FINE
CH.3	0-255	TILT
CH.4	0-255	TILT FINE
CH.5	0-255	PT SPEED
CH.6	0-255	ZOOM
CH.7	0-255	RED RING
CH.8	0-255	GREEN RING
CH.9	0-255	BULE RING
CH.10	ring color effect	
	000-009	Open
	010-014	RED
	015-019	GREEN
	020-024	BLUE
	025-029	Yellow
	030-034	Magenta
	035-039	Cyan
	040-044	WHITE
	045-049	Violet blue
	050-054	Light blue
	055-059	Wine red
	060-064	May green
	065-069	Reseda green
	070-074	Blue lilac
	075-079	Moss green
	080-084	Signal violet
	085-089	Red lilac
	090-094	Purple red
	095-099	Green brown
	100-104	Pale green
	105-109	Ruby red
	110-114	Flame red
	115-119	Red orange
	120-124	Rose
125-129	Honey yellow	

PIXEL (Ch92)	VALUE	FUNCTION
	130-134	Light Pin
	135-139	Deep orange
	140-144	Lemmon
	145-149	Golden yellow
	150-154	Pastel orange
	155-159	Cream
	160-164	Melon yellow
	165-169	Luminous orange
	170-174	Luminouse yellow
	175-179	Open
	180-248	Stop
	249-255	Open
CH.11	Color FX	
	000-009	Open
	010-023	FX1
	024-037	FX2
	038-051	FX3
	052-065	FX4
	066-079	FX5
	080-093	FX6
	094-107	FX7
	108-121	FX8
	122-135	FX9
	136-149	FX10
	150-163	FX11
	164-177	FX12
	178-191	Fx13
	192-205	Fx14
	206-219	Fx15
	220-233	Fx16
	234-247	Fx17
	248-255	Close
CH.12	0-255	Ring Speed(SPEED 1 → 100%)
CH.13	0-255	Ring DIMMER
Control (will be active after 5 seconds on the corresponding value)		



NEPTUNE 400 WASH SS672

PIXEL (Ch92)	VALUE	FUNCTION
CH.14	0-9	NO FUNCTION
	10-19	PAN/TILT BLACK ACTIVATED
	20-29	PAN/TILT BLACK DEACTIVATED
	30-59	DIM0
	60-69	DIM1
	70-79	DIM2
	80-89	DIM3
	90-99	DIM4
	100-139	PWM 1200Hz
	140-149	PWM 2000Hz
	150-159	PWM 2400Hz
	160-169	PWM 6000Hz
	170-179	PWM 25000Hz
	180-189	STUDIO
	190-199	POWER
	200-209	LIVE
	210-219	pan/tilt reset
	220-229	ZOOM RESET
	230-239	Total Reset
	240-255	NO FUNCTION
CH.15	0-255	DIMMER
STROBE		
CH.16	0-9	NO FUNCTION
	10-99	STROBE FROM (SLOD TO FAST , 0-25Hz)
	100-109	NO FUNCTION
	110-179	LIGHTNING STROBE
	180-189	NO FUNCTION
	190-255	RANDOM STROBE
CH.17	0-255	RED 1
CH.18	0-255	GREEN1
CH.19	0-255	BLUE1
CH.20	0-255	White1
CH.21	0-255	RED2
CH.22	0-255	GREEN2
CH.23	0-255	BLUE2

PIXEL (Ch92)	VALUE	FUNCTION
CH.24	0-255	White 2
CH.25	0-255	RED3
CH.26	0-255	GREEN3
CH.27	0-255	BLUE3
CH.28	0-255	White3
CH.29	0-255	RED4
CH.30	0-255	GREEN4
CH.31	0-255	BLUE4
CH.32	0-255	White4
CH.33	0-255	RED 5
CH.34	0-255	GREEN5
CH.35	0-255	BLUE5
CH.36	0-255	White 5
CH.37	0-255	RED 6
CH.38	0-255	GREEN6
CH.39	0-255	BLUE6
CH.40	0-255	White 6
CH.41	0-255	RED 7
CH.42	0-255	GREEN7
CH.43	0-255	BLUE7
CH.44	0-255	White 7
CH.45	0-255	RED 8
CH.46	0-255	GREEN8
CH.47	0-255	BLUE8
CH.48	0-255	White 8
CH.49	0-255	RED 9
CH.50	0-255	GREEN9
CH.51	0-255	BLUE9
CH.52	0-255	White 9
CH.53	0-255	RED 10
CH.54	0-255	GREEN 10
CH.55	0-255	BLUE 10
CH.56	0-255	White 10
CH.57	0-255	RED 11
CH.58	0-255	GREEN 11



NEPTUNE 400 WASH SS672

PIXEL (Ch92)	VALUE	FUNCTION
CH.59	0-255	BLUE 11
CH.60	0-255	White 11
CH.61	0-255	RED 12
CH.62	0-255	GREEN 12
CH.63	0-255	BLUE 12
CH.64	0-255	White 12
CH.65	0-255	RED 13
CH.66	0-255	GREEN 13
CH.67	0-255	BLUE 13
CH.68	0-255	White 13
CH.69	0-255	RED 14
CH.70	0-255	GREEN 14
CH.71	0-255	BLUE 14
CH.72	0-255	White 14
CH.73	0-255	RED 15
CH.74	0-255	GREEN 15
CH.75	0-255	BLUE 15
CH.76	0-255	White 15
CH.77	0-255	RED 16
CH.78	0-255	GREEN 16
CH.79	0-255	BLUE 16
CH.80	0-255	White 16
CH.81	0-255	RED 17
CH.82	0-255	GREEN 17
CH.83	0-255	BLUE 17
CH.84	0-255	White 17
CH.85	0-255	RED 18
CH.86	0-255	GREEN 18
CH.87	0-255	BLUE 18
CH.88	0-255	White 18
CH.89	0-255	RED 19
CH.90	0-255	GREEN 19
CH.91	0-255	BLUE 19
CH.92	0-255	White 19

CMY (Ch23)	VALUE	FUNCTION
CH.1	0-255	PAN
CH.2	0-255	PAN FINE
CH.3	0-255	TITL
CH.4	0-255	TITL FINE
CH.5	0-255	PT SPEED
CH.6	0-255	CYAN
CH.7	0-255	MAGENT
CH.8	0-255	YELLOW
CH.9	0-255	DIMMER
CH.10	FUNCTION	
	0-9	NO FUNCTION
	10-99	STROBE FROM (SLOW TO FAST , 0-25Hz)
	100-109	NO FUNCTION
	110-179	LIGHTNING STROBE
	180-189	NO FUNCTION
	190-255	RANDOM STROBE
CH.11	COLOR MARCOS	
	0-10	NO FUNCTION
	11-30	CYAN 100% / MAGENTA UP / YELLOW 0%
	31-50	CYAN DOWN / MAGENTA 100% / YELLOW 0%
	51-70	CYAN 0% / MAGENTA 100% / YELLOW UP
	71-90	CYAN 0% / MAGENTA DOWN / YELLOW 100%
	91-110	CYAN UP / MAGENTA 0% / YELLOW 100%
	111-130	CYAN 100% /MAGENTA 0%/YELLOW DOWN
	131-150	CYAN 100%/MAGENTA UP/YELLOW 0%
	151-170	CYAN DOWN/MAGENTA DOWN/YELLOW 100%
	171-195	ALL LED AT FULL OUTPUT
	196-199	1800K
	200-203	2200K
	204-207	2700K
	208-211	3000K
	212-215	3200K
216-219	3500K	
220-223	4000K	
224-227	4200K	



NEPTUNE 400 WASH SS672

CMY (Ch23)	VALUE	FUNCTION
	228-231	4500K
	232-235	5600K
	236-239	6000K
	240-243	6500K
	244-247	7200K
	248-255	8000K
CH.18	STATIC PIXEL	
	0~9	NO FUNCTION
	10-13	1
	14-17	2
	18-21	3
	22-25	4
	26-29	5
	30-33	6
	34-37	7
	38-41	8
	42-45	9
	46-49	10
	50-53	11
	54-57	12
	58-61	13
	62-65	14
	66-69	15
	70-73	16
	74-77	17
	78-81	18
	82-85	19
	86-89	1,2
	90-93	3,4
94-97	5,6	
98-101	7,8	
102-105	9,10	
106-109	11,12	
110-113	13,14	
114-117	15,16	

CMY (Ch23)	VALUE	FUNCTION
	118-121	17,18
	122-125	19,1
	126-129	1,2,3
	130-133	1,4,5
	134-137	1,6,7
	138-141	2,8,9
	142-145	3,10,11
	146-149	4,12,13
	150-153	5,14,15
	154-157	6,16,17
	158-161	7,18,19
	162-165	1,2,3,4
	166-169	1,5,6,7
	170-173	8,9,10,11
	174-177	12,13,14,15
	178-181	16,17,18,19
	182-185	2,3,4,5,6,7
	186-189	1,4,5,6,7
	190-193	8,9,10,11,12
	194-197	13,14,15,16,17
	198-201	18,19,8,9,10
	202-205	1,2,3,4,6,7
	206-209	8,9,10,11,12,13
	210-213	14,15,16,17,18,19
	214-217	1,2,3,4,5,6,7
	218-221	8,9,10,11,12,13,14,15,16,17,18,19
	222-225	1,2,3,4,8,9,10,11,12,13
	226-229	1,5,6,7,14,15,16,17,18,19
	230-233	1,2,3,6,7,8,9,10,17,18,19
	234-237	1,3,4,5,6,11,12,13,14,15,16
	238-241	1,2,3,4,5,6,7,8,10,12,14,16,18
	242-245	1,2,3,4,5,6,7,9,11,13,15,17,19
	246-249	1,2,4,6,8,10,12,14,16,18
	250-253	1,3,5,7,9,11,13,15,17,19
	254-255	null



NEPTUNE 400 WASH SS672

CMY (Ch23)	VALUE	FUNCTION
CH.13	PIXEL EFFECT	
	0-9	NO FUNCTION
	10-13	1-19(Single light cycling operation,associated with CH4-CH10)
	14-17	19-1(Single light cycling operation,associated withCH4-CH10)
	18-21	1-19-1(Single light cycling operation,associated with CH4-CH10)
	22-25	1-10 and 19-10(1&19light up in the same time,gethering from 2 sides to the center in turn .when it is at 10 ,spreading from the center to the 2 sides,associated with CH4-CH10)
	26-29	1 (Illuminance 30%) - 2 (Illuminance60%) 3 (Illuminance100%) , (associated with CH4-CH10)
		2 (Illuminance 30%) - 3 (Illuminance60%) 4 (Illuminance100%) , (associated with CH4-CH10)
		3 (Illuminance 30%) - 4 (Illuminance60%) 5 (Illuminance100%) , (associated with CH4-CH10)
		4 (Illuminance 30%) - 5 (Illuminance60%) 6 (Illuminance100%) , (associated with CH4-CH10)
		5 (Illuminance 30%) - 6 (Illuminance60%) 7 (Illuminance100%) , (associated with CH4-CH10).....
		18 (Illuminance 30%) - 19 (Illuminance60%) 1 (Illuminance100%) , (associated with CH4-CH10)
		19 (Illuminance 30%) - 1 (Illuminance60%) 2 (Illuminance100%) , (associated with CH4-CH10)
	30-337 (Illuminance 30%) - 6 (Illuminance60%) 5 (Illuminance100%) , (associated with CH4-CH10)
		6 (Illuminance 30%) - 5 (Illuminance60%) 4 (Illuminance100%) , (associated with CH4-CH10)
		5 (Illuminance 30%) - 4 (Illuminance60%) 3 (Illuminance100%) , (associated with CH4-CH10)
		4 (Illuminance 30%) - 3 (Illuminance60%) 2 (Illuminance100%) , (associated with CH4-CH10)
		3 (Illuminance 30%) - 2 (Illuminance60%) 1 (Illuminance100%) , (associated with CH4-CH10)
		2 (Illuminance 30%) - 1 (Illuminance60%) 19 (Illuminance100%) , (associated with CH4-CH10)
		1 (Illuminance 30%) - 19 (Illuminance60%) 18 (Illuminance100%) , (associated with CH4-CH10)
	34-37	1-19(Single 2700k cycling operation ,the background effect associated with CH4-CH10)
	38-41	19-1(Single 2700k cycling operation ,the background effect associated with CH4-CH10)
	42-45	1-19-1(Single 2700k cycling operation ,the background effect associated with CH4-CH10)
	46-49	1-10 and 19-10(1<2700k>&7<2700K>light up in the same time,gethering from 2 sides to the center in turn .when it is at 10,spreading from the center to the 2 sides,the background effect associated with CH4-CH10)
	50-53	1-19(Single 6000k cycling operation ,the background effect associated with CH4-CH10)
	54-57	19-1(Single 6000k cycling operation ,the background effect associated with CH4-CH10)
	58-61	1-19-1(Single 6000k cycling operation ,the background effect associated with CH4-CH10)
	62-65	1-10 and 19-10(1<6000k>&7<6000K>light up in the same time,gethering from 2 sides to the center in turn .when it is at 10,spreading from the center to the 2 sides,the background effect associated with CH4-CH10)
	66-69	Red background ,illumincance adjustable . 100% green lightness runs(1-19)
	70-73	Red background ,illumincance adjustable . 100% green lightness runs(19-1)
	74-77	Red background ,illumincance adjustable . 100% green lightness runs(1-19-1)

CMY (Ch23)	VALUE	FUNCTION
	78-81	Red background ,illuminate adjustable . 100% green lightness runs(1-10,19-10),1&19light up in the same time,gethering from 2 sides to the center in turn .when it is at 10,spreading from the center to the 2 sides.associated with CH4-CH10.
	82-85	Green background ,illuminate adjustable . 100% blue lightness runs(1-19)
	86-89	Green background ,illuminate adjustable . 100% blue lightness runs(19-1)
	90-93	Green background ,illuminate adjustable . 100% blue lightness runs(1-19-1)
	94-97	Green background ,illuminate adjustable . 100% blue lightness runs(1-10,19-10),1&19light up in the same time,gethering from 2 sides to the center in turn .when it is at 10,spreading from the center to the 2 sides.associated with CH4-CH10.
	98-101	Blue background ,illuminate adjustable . 100% green lightness runs(1-19)
	102-105	Blue background ,illuminate adjustable . 100% green lightness runs(19-1)
	106-109	Blue background ,illuminate adjustable . 100% green lightness runs(1-19-1)
	110-113	Blue background ,illuminate adjustable . 100% green lightness runs(1-10,19-10),1&19 light up in the same time,gethering from 2 sides to the center in turn .when it is at 10,spreading from the center to the 2 sides.associated with CH4-CH10.
	114-117	Red background ,illuminate adjustable . 100% white lightness runs(1-19)
	118-121	Red background ,illuminate adjustable . 100% white lightness runs(19-1)
	122-125	Red background ,illuminate adjustable . 100% white lightness runs(1-19-1)
	126-129	Red background ,illuminate adjustable . 100% white lightness runs(1-10,19-10),1&19 light up in the same time,gethering from 2 sides to the center in turn .when it is at 10,spreading from the center to the 2 sides.associated withCH4-CH10.
	130-133	White background ,illuminate adjustable . 100% red lightness runs(1-19)
	134-137	White background ,illuminate adjustable . 100% red lightness runs(19-1)
	138-141	White background ,illuminate adjustable . 100% red lightness runs(1-19-1)
	142-145	White background ,illuminate adjustable . 100% red lightness runs(1-10,19-10),1&19 light up in the same time,gethering from 2 sides to the center in turn .when it is at 10,spreading from the center to the 2 sides.associated with CH4-CH10.
	146-149	Green background ,illuminate adjustable . 100% white lightness runs(1-19)
	150-153	Green background ,illuminate adjustable . 100% white lightness runs(19-1)
	154-157	Green background ,illuminate adjustable . 100% white lightness runs(1-19-1)
	158-161	Green background ,illuminate adjustable . 100% white lightness runs(1-10,19-10),1&19 light up in the same time,gethering from 2 sides to the center in turn .when it is at 10,spreading from the center to the 2 sides.associated with CH4-CH10.
	162-165	Blue background ,illuminate adjustable . 100% white lightness runs(1-19)
	166-169	Blue background ,illuminate adjustable . 100% white lightness runs(19-1)
	170-173	Blue background ,illuminate adjustable . 100% white lightness runs(1-19-1)
	174-177	Blue background ,illuminate adjustable . 100% white lightness runs(1-10,19-10),1&19 light up in the same time,gethering from 2 sides to the center in turn .when it is at 10,spreading from the center to the 2 sides.associated with CH4-CH10.
	178-181	Green background ,illuminate adjustable . 100% red lightness runs(1-19)
	182-185	Green background ,illuminate adjustable . 100% red lightness runs(19-1)
	186-189	Green background ,illuminate adjustable . 100% red lightness runs(1-19-1)



NEPTUNE 400 WASH SS672

CMY (Ch23)	VALUE	FUNCTION
	190-193	Green background ,illuminate adjustable . 100% red lightness runs(1-10,19-10),1&19 light up in the same time,gathering from 2 sides to the center in turn .when it is at 10,spreading from the center to the 2 sides.associated with CH4-CH10.
	194-197	Blue background ,illuminate adjustable . 100% red lightness runs(1-19)
	198-201	Blue background ,illuminate adjustable . 100% red lightness runs(19-1)
	202-205	Blue background ,illuminate adjustable . 100% red lightness runs(1-19-1)
	206-209	Blue background ,illuminate adjustable . 100% red lightness runs(1-10,19-10),1&19 light up in the same time,gathering from 2 sides to the center in turn .when it is at 10,spreading from the center to the 2 sides.associated with CH4-CH10.
	210-215	small-middle-big-middle-small circular ring
	216-221	(1,4,5)-(2,5,6)-(3,6,7)-(4,7,1)-(5,1,2)-(6,2,3)-(7,3,4)
	222-227	(1,2,5,6)-(2,3,6,7)-(3,4,7,1)-(4,5,1,2)-(5,6,2,3)-(6,7,3,4)-(7,1,4,5)
	228-230	1,2 circular ring
	231-233	1,2,3 circular ring
	234-236	1,2,3,4 circular ring
	237-239	1-3blue , 4-7red
	240-242	1-3cyan , 4-7orange
	243-245	1-3purple , 4-7yellow
	246-248	1-3orange , 4-7green
	249-251	1-3red , 4-7purple
	252-254	1-3yellow , 4-7blue
	255	1-3green , 4-7purple
CH.14	0-255	AUTO SPEED ADJUSTMENT(SLOW TO FAST)
CH.15	0-255	ZOOM
CH.16	0-255	RED RING
CH.17	0-255	GREEN RING
CH.18	0-255	BULE RING
		Ring Color Presets
	000-009	Open
	010-014	RED
	015-019	GREEN
	020-024	BLUE
	025-029	Yellow
	030-034	Magenta
CH.19	035-039	Cyan
	040-044	WHITE
	045-049	Violet blue

CMY (Ch23)	VALUE	FUNCTION
	050-054	Light blue
	055-059	Wine red
	060-064	May green
	065-069	Reseda green
	070-074	Blue lilac
	075-079	Moss green
	080-084	Signal violet
	085-089	Red lilac
	090-094	Purple red
	095-099	Green brown
	100-104	Pale green
	105-109	Ruby red
	110-114	Flame red
	115-119	Red orange
	120-124	Rose
	125-129	Honey yellow
	130-134	Light Pin
	135-139	Deep orange
	140-144	Lemmon
	145-149	Golden yellow
	150-154	Pastel orange
	155-159	Cream
	160-164	Melon yellow
	165-169	Luminous orange
	170-174	Luminouse yellow
	175-179	Open
	180-248	Stop
	249-255	Open
	Color FX	
CH.20	000-009	Open
	010-023	FX1
	024-037	FX2
	038-051	FX3
	052-065	FX4
	066-079	FX5



NEPTUNE 400 WASH SS672

CMY (Ch23)	VALUE	FUNCTION
	080-093	FX6
	094-107	FX7
	108-121	FX8
	122-135	FX9
	136-149	FX10
	150-163	FX11
	164-177	FX12
	178-191	Fx13
	192-205	Fx14
	206-219	Fx15
	220-233	Fx16
	234-247	Fx17
	248-255	Close
CH.21	0-255	Ring Speed(SPEED 1 → 100%)
CH.22	0-255	Ring Dimmer
CH.23	Control (will be active after 5 seconds on the corresponding value)	
	0-9	NO FUNCTION
	10-19	PAN/TILT BLACK ACTIVATED
	20-29	PAN/TILT BLACK DEACTIVATED
	30-59	DIM0
	60-69	DIM1
	70-79	DIM2
	80-89	DIM3
	90-99	DIM4
	100-139	PWM 1200Hz
	140-149	PWM 2000Hz
	150-159	PWM 2400Hz
	160-169	PWM 6000Hz
	170-179	PWM 25000Hz
	180-189	STUDIO
	190-199	POWER
	200-209	LIVE
210-219	pan/tilt reset	
220-229	ZOOM RESET	
230-239	Total Reset	

CMY (Ch23)	VALUE	FUNCTION
	240-255	NO FUNCTION

